

P/N: 41451533

# UNI-T®



## UT232

Operating Manual

Digital Power  
Clamp Meter

**UNI-T®**

**Model UT232  
OPERATING MANUAL**

## TABLE OF CONTENTS

TITLE	PAGE
Overview .....	3
Unpacking Inspection .....	3
Safety Information .....	4
Rules For Safe Operation .....	4
International Electrical Symbols .....	6
The Meter Structure .....	7
A.The Meter Front Structure .....	7
B.The Meter Back and Bottom Structure .....	8
Functional Buttons .....	9
Display Symbols .....	12
Measurement Operation .....	14
A. AC Voltage + Frequency Measurement .....	14
B. AC Current + AC Voltage Measurement .....	16
C. Active Power + Phase Angle Measurement .....	18
D. Apparent Power + Reactive Power Measurement .....	25
E. Power Factor + Phase Angle Measurement .....	27
F. Active Energy + Time Measurement .....	29
True RMS Measurement and Average Value Measurement .....	31
Specifications .....	32

### TABLE OF CONTENTS

TITLE	PAGE
A. General Specifications	32
B. Environmental Requirements	33
Accuracy Specifications	34
A. AC Voltage	34
B. Frequency	34
C. AC Current	35
D. Active Power	35
E. Apparent Power	36
F. Reactive Power	37
G. Power Factor	38
H. Phase Angle	38
I. Active Energy	39
Maintenance	39
A. General Service	39
B. Replacing the Battery	40

### Overview

This Operating Manual covers information on safety and cautions. Please read the relevant information carefully and observe all the **Warnings** and **Notes** strictly.

#### Warning

**To avoid electric shock or personal injury, read the “Safety Information” and “Rules for Safe Operation” carefully before using the Meter.**

**Model UT232** is a three phase intelligent handheld digital power clamp meter (hereafter referred to as “the Meter”) which has both the features of digital current meter and also power measurement meter.

The Meter can measure Voltage, Current, Active Power, Apparent Power, Reactive Power, Power Factor, Phase Angle, Frequency, Active Energy and etc.

### Unpacking Inspection

Open the package case and take out the Meter. Check the following items carefully to see any missing or damaged part:

Item	Description	Qty
1	English Operating Manual	1 piece
2	Red Test Lead	1 piece
3	Black Test Lead	1 piece
4	Blue Test Lead	1 piece
5	Yellow Test Lead	1 piece
6	Red Alligator Clip	1 piece
7	Black Alligator Clip	1 piece
8	Blue Alligator Clip	1 piece
9	Yellow Alligator Clip	1 piece
10	USB Interface Cable	1 piece
11	Software	1 piece
12	Tool Box	1 piece
13	1.5V Battery (LR6)	4 pieces

In the event you find any missing or damage, please contact your dealer immediately.

## Safety Information

This Meter complies with the standards IEC61010: in pollution degree 2, overvoltage category (CAT. III 600V, CAT IV 300V) and double insulation.

CAT. III: Distribution level, fixed installation, with smaller transient overvoltages than CAT. IV

CAT.IV: Primary supply level, overhead lines, cable systems etc.

Use the Meter only as specified in this operating manual, otherwise the protection provided by the Meter may be impaired.

In this manual, a **Warning** identifies conditions and actions that pose hazards to the user, or may damage the Meter or the equipment under test.

A **Note** identifies the information that user should pay attention to.

International electrical symbols used on the Meter and

in this Operating Manual are explained on page 6.

## Rules For Safe Operation







### Warning

**To avoid possible electric shock or personal injury, and to avoid possible damage to the Meter or to the equipment under test, adhere to the following rules:**

- 1 **Before using the Meter inspect the case. Do not use the Meter if it is damaged or the case (or part of the case) is removed. Look for cracks or missing plastic. Pay attention to the insulation around the connectors.**
- 1 **Inspect the test leads for damaged insulation or exposed metal. Replace damaged test leads with identical model number or electrical specifications before using the Meter.**
- 1 **Do not apply more than the rated voltage, as marked on the Meter.**
- 1 **When measurement has been completed, disconnect the connection between the test leads and the circuit under test, remove the**

- testing leads away from the input terminals of the Meter and turn the Meter power off.
- 1 Do not carry out the measurement when the Meter's back case and / or battery door is opened to avoid electric shock.
- 1 When the Meter working at an effective voltage over 30V in AC, special care should be taken.
- 1 Use the proper terminals and function for your measurements.
- 1 Do not use or store the Meter in an environment of high temperature, humidity, explosive, inflammable and strong magnetic field. The performance of the Meter may deteriorate after dampened.
- 1 Do not use the Meter if the surface of it is wet or the user's hands are wet.
- 1 When using the test leads, keep your fingers behind the finger guards.
- 1 Replace the battery as soon as the battery indicator  appears. With a low battery, the Meter might produce false readings that can lead to electric shock and personal injury.
- 1 When opening the battery door, must make sure the Meter is power off.
- 1 When servicing the Meter, use only the same model number or identical electrical specifications replacement parts.
- 1 The internal circuit of the Meter shall not be altered at will to avoid damage of the Meter and any accident.
- 1 Soft cloth and mild detergent should be used to clean the surface of the Meter when servicing. No abrasive and solvent should be used to prevent the surface of the Meter from corrosion, damage and accident.
- 1 The Meter is suitable for indoor use.
- 1 Turn the Meter off when it is not in use and take out the battery when not using for a long time.
- 1 Constantly check the battery as it may leak when it has been using for some time, replace the battery as soon as leaking appears. A leaking battery will damage the Meter.

## International Electrical Symbols

	AC (Alternating Current)
	Grounding
	Double Insulated
	Warning. Refer to the Operating Manual
	Deficiency of Built-In Battery
	Danger of High Voltage
	Conforms to Standards of European Union



## The Meter Structure

### A. The Meter Front Structure (see figure 1)

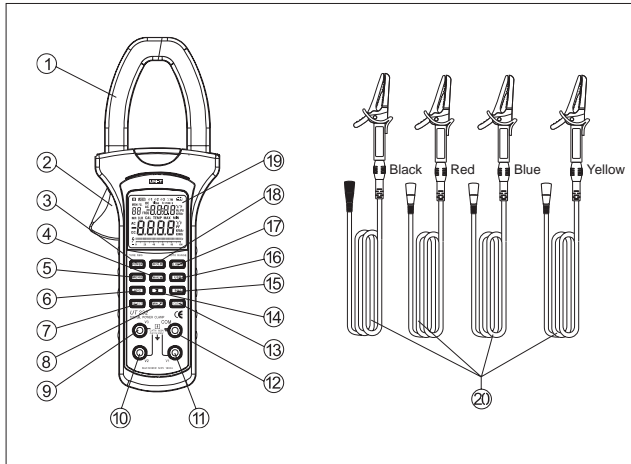

Figure 1

①	Transformer Jaw: designed to pick up the AC and DC current flowing through the conductor. It could transfer current to voltage. The tested conductor must vertically go through the Jaw center.
②	Hand Guards: to protect user's hand from touching the dangerous area.
③	Power button
④	Max/▲ button
⑤	MENU button
⑥	LOAD button (recall data)
⑦	SELECT button (press to select alternate function and sum of Watts measurement)
⑧	MIN/▼ button
⑨	V3 Input Terminal (Third phase measurement)
⑩	V2 Input Terminal (Second phase measurement)
⑪	V1 Input Terminal (First phase measurement)
⑫	COM Input Terminal
⑬	CLEAR button (maximum and minimum)

⑭	Σ button (Sum)
⑮	SAVE button (data store button)
⑯	USB button
⑰	LIGHT button (auto display backlight button)
⑱	HOLD button
⑲	LCD Display
⑳	Testing Leads (Red, Black, Blue and Yellow)

### B. The Meter Back and Bottom Structure (see figure 2)

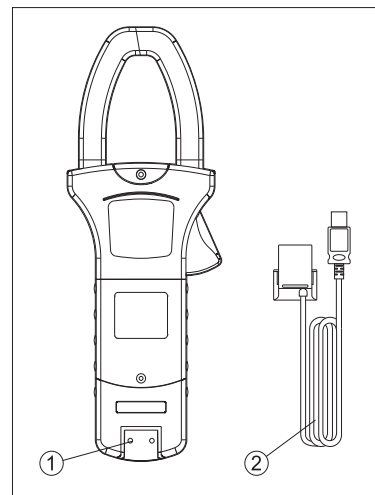



Figure 2

①	Infrared slot
②	USB Interface Cable

## Functional Buttons

Below table indicated for information about the functional button operations.

Button	Operation Performed
<b>POWER</b>	Press and hold <b>POWER</b> for 1 second to turn the Meter on. Press <b>POWER</b> again to turn the Meter off.
<b>HOLD</b>	<ul style="list-style-type: none"> <li>● Press <b>HOLD</b> to enter the Hold mode in any mode,  appears and the Meter beeps.</li> <li>● Press <b>HOLD</b> again to exit the Hold mode to return to measurement mode, the Meter beeps and  disappears.</li> </ul>
<b>LIGHT</b>	<ul style="list-style-type: none"> <li>● Press <b>LIGHT</b> to turn the display backlight on.</li> <li>● The display backlight will be off automatically after 30 seconds.</li> </ul>
<b>MENU</b>	Press <b>MENU</b> to display the following functions in sequence: <ul style="list-style-type: none"> <li>● AC Voltage (main display) + Frequency</li> </ul>

Button	Operation Performed
<b>MENU</b>	(secondary display) <ul style="list-style-type: none"> <li>● AC Current (main display) + AC Voltage (secondary display)</li> <li>● Active power (main display) + Phase angle (secondary display)</li> <li>● Apparent power (main display) + Reactive power (secondary display)</li> <li>● Power factor (main display) + Phase angle (secondary display)</li> <li>● Active Energy (main display) + Time (secondary display)</li> </ul>
<b>MAX/▲</b>	<ul style="list-style-type: none"> <li>● Press to start recording of maximum value, it valid at voltage, current, active power and apparent power ranges only.</li> <li>● Press once at LOAD mode, MR icon shown, the Meter displays the next stored reading, the left secondary display showing the index increase one.</li> <li>● Press once at <math>\Sigma</math> mode, CAL icon shown,</li> </ul>

Button	Operation Performed
<b>MAX/▲</b>	the Meter steps through sum of active power (main display) + sum of reactive power (secondary display) and sum of power factor (main display) + sum of apparent power.
<b>USB</b>	<ul style="list-style-type: none"> <li>● Press <b>USB</b> once to turn the USB interface on, USB appears and the Meter beeps.</li> <li>● Press <b>USB</b> again to turn the USB interface off, USB disappears and the Meter beeps.</li> <li>● It is invalid at active energy mode</li> </ul>
<b>LOAD</b>	<ul style="list-style-type: none"> <li>● Press once to enter LOAD mode, MR appears and the Meter beeps.</li> <li>● Press again to exit LOAD mode, MR disappears and the Meter beeps.</li> <li>● Press and hold <b>LOAD</b> for 1 second to display the stored data quickly.</li> </ul>
$\Sigma$	<ul style="list-style-type: none"> <li>● At Active power (main display) + Phase angle (secondary display) mode, press <math>\Sigma</math> once button to sum up the current</li> </ul>

Button	Operation Performed
$\Sigma$	<p>first phase of 3 phase measurement result. Then carry out second phase power measurement.</p> <ul style="list-style-type: none"> <li>● Press <math>\Sigma</math> again to sum up the second phase power measurement result, then carry out third phase power measurement.</li> <li>● Press <math>\Sigma</math> again to sum up the third phase power measurement result, then press <b>SELECT</b> to enter the measurement of sum of the watts mode, the display shows the 3 phase sum of the watts value.</li> </ul>
<b>SAVE</b>	<ul style="list-style-type: none"> <li>● Press once to store single reading, MEM appears and the Meter beeps.</li> <li>● Press and hold for over 1 second to continuous store reading, MEM blinks and the Meter beeps. The index number shown on the left secondary display keep on increasing. Press <b>SAVE</b> again</li> </ul>

## Model UT232: OPERATING MANUAL

Button	Operation Performed
	to exit. The maximum number of data store is 99, when it achieves 99, the Meter shows FUL. Press <b>CLEAR</b> to clear the stored reading in order to store next reading.
<b>SELECT</b>	<ul style="list-style-type: none"> <li>● At active power (main display) + phase angle (secondary display) mode, press <b>SELECT</b> button to step through first phase, second phase, third phase and sum of watts.</li> <li>● At other mode, press <b>SELECT</b> to step through first phase, second phase and the third phase.</li> </ul>
<b>MIN / ▼</b>	<ul style="list-style-type: none"> <li>● Press to start recording of minimum value, it valid at voltage, current, active power and apparent power ranges only.</li> <li>● Press once at LOAD mode, MR icon shown, the Meter displays the previous stored reading, the left secondary display showing the index decrease one.</li> <li>● Press once at <math>\Sigma</math> mode, CAL icon shown,</li> </ul>

Button	Operation Performed
	the Meter steps through sum of active power (main display) + sum of reactive power (secondary display) and sum of power factor (main display) + sum of apparent power.
<b>CLEAR</b>	<ul style="list-style-type: none"> <li>● At active energy range, press to reset time the zero, then restart the timing.</li> <li>● At all other ranges, press to clear stored readings.</li> </ul>

### Display Symbols (see figure 3)

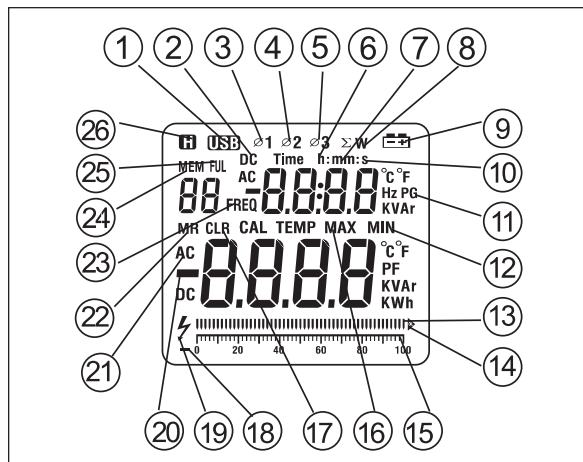









Figure 3

Number	Symbol	Meaning
①	<b>USB</b>	Data Output is in progress
②	<b>DC</b>	Indicator for DC measurement
③	Ø1	First phase symbol
④	Ø2	Second phase symbol
⑤	Ø3	Third phase symbol
⑥	<b>h</b>	Unit for hour
⑦	<b>mm</b>	Unit for minute
⑧	<b>ΣW</b>	Watt: Sum of Watt
⑨		The battery is low. <b>⚠Warning: To avoid false readings, which could lead to possible electric shock or personal injury, replace the battery as soon as the battery indicator appears.</b>
⑩	<b>s</b>	Unit for second
⑪	<b>Hz, PG, KVAR</b>	Symbol of Unit. Hz: Hertz. The unit of frequency. PG: The unit of phase angle KVAR. The unit of reactive power

## Model UT232: OPERATING MANUAL

Number	Symbol	Meaning
⑫	<b>MIN</b>	Minimum reading
⑬		Analogue Bar Graph
⑭		Overloading
⑮		Ruler
⑯	<b>MAX</b>	Maximum reading
⑰	<b>CLR</b>	Indicator for clear the stored reading
⑱		Ruler negative symbol
⑲		High voltage symbol
⑳		Indicates negative reading
㉑	<b>AC</b>	Indicator for AC voltage or current
㉒	<b>MR</b>	Indicator for recall the stored reading
㉓	<b>FREQ</b>	Frequency symbol
㉔	<b>MEM</b>	Indicator for data store
㉕	<b>FUL</b>	Indicator for data stored is full
㉖		Data hold is active

### Measurement Operation

#### Preparation

- Press and hold **POWER** for one second to turn the Meter on. The default range is the last measurement range when you turned off the Meter.
- Replace the battery as soon as the battery indicator “” appears on the display.

#### A. AC Voltage (main display) + Frequency (secondary display) Measurement (see figure 4)

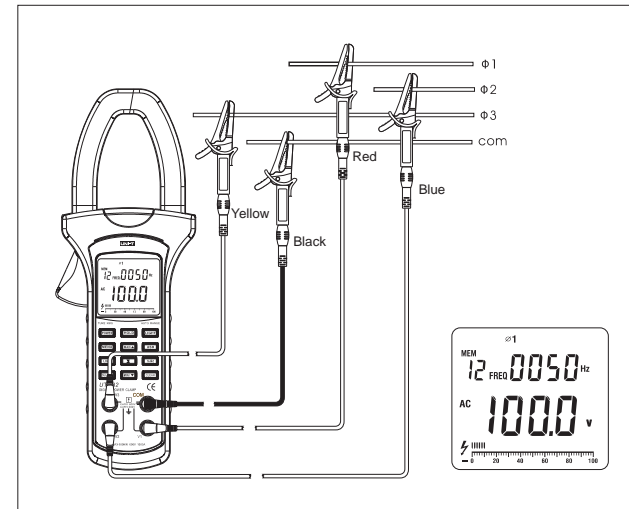

Figure 4



## Model UT232: OPERATING MANUAL

The AC Voltage ranges are:15V, 100V, 300V and 600V

The frequency range is:20Hz~500Hz

To measure AC voltage + frequency, connect the Meter as follows:

1. Insert the red test lead into the **V1** terminal, blue test lead into the **V2** terminal, yellow test lead to **V3** input terminal and black test lead to the **COM** input terminal.
2. Press the **MENU** to select Voltage (main display) + Frequency (secondary display) range.
3. Connect the red test leads (**V1** input terminal), blue test leads (**V2** input terminal) and yellow test leads (**V3** input terminal) to the corresponding three phases loaded live wire. Black test lead (COM input terminal) to the corresponding three phases loaded neutral wire.
4. Press **SELECT** to select phase location, the display shows the corresponding phase symbol. **V1** means the first phase  $\varnothing 1$ , **V2** means the first phase  $\varnothing 2$ , **V3** means the first phase  $\varnothing 3$ .
5. The display shows the corresponding True RMS voltage value and frequency value of each phase.
6. Press **MAX/▲**, the LCD displays MAX, it starts recording the maximum AC voltage True RMS value. Press **MAX/▲** again to show the current AC voltage True RMS value.
7. Press **MIN/▼** the LCD displays MAX, it starts recording the minimum AC voltage True RMS value. Press **MAX/▲** again to show the current AC voltage True RMS value.
8. The display shows **OL** when the input voltage is higher than 600V rms.

### Note

- When the measurement has been completed, disconnect the connection between the testing leads and the circuit under test and remove testing leads from the input terminals.

### B. AC Current (main display) + AC Voltage (secondary display) Measurement (see figure 5)

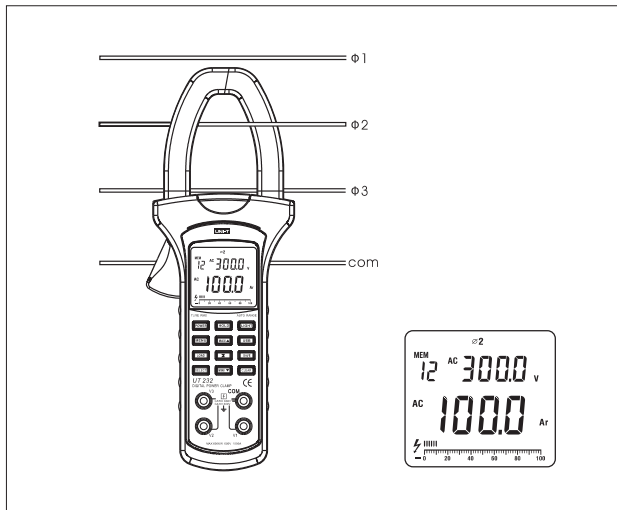

Figure 5

The AC current ranges are: 40A, 100A, 400A and 1000A

The AC Voltage ranges are: 15V, 100V, 300V and 600V

To measure AC current + AC voltage, connect the Meter as follows:

1. Press the **MENU** to select AC Current (main display) + AC Voltage (secondary display) range.
2. Press the lever to open the transformer jaw.
3. Center the conductor within the transformer jaw, then release the Meter slowly until the transformer jaw is completely closed, Make sure the conductor to be tested is placed at the center of the transformer jaw, otherwise it will cause deviation. The Meter can only measure one conductor at a time, to measure more than one conductor at a time will cause deviation.
4. The double display shows the AC current True RMS value and AC voltage True RMS value.
5. Press **MAX/▲**, the LCD displays MAX, it starts recording the maximum AC current True RMS value. Press **MAX/▲** again to show the present AC

- True RMS value.
6. Press **MIN/▼**, the LCD displays MAX, it starts recording the minimum AC current True RMS value. Press **MAX/▲**, again to show the present AC current True RMS value.
  7. The display shows **OL** when the current of the tested conductor is higher than 1000A rms.

### Note

- When the measurement has been completed, disconnect the connection between the conductor under test and the jaw, and remove the conductor away from the transformer jaw of the Meter.

### C. Active Power (main display) + Phase Angle (secondary display) Measurement

The active power ranges are:  
40A, 100A, 400A and 1000A

The phase angle ranges are:  $0^{\circ}$  ~ $360^{\circ}$



#### Warning

**To avoid damages to the Meter or harms to you, do you measure higher than AC voltage 600 v.r.s. and AC current 1000A v.r.s.**

To measure active power + phase angle, connect the Meter as follows:

1. Press the **MENU** to select Active power (main display) + Phase angle (secondary display) range.
2. Press the lever to open the transformer jaw, and clamp them to the corresponding phase of tested conductor. If user needs to measure any phase of the 3 phase, then clamp them to that phase's conductor.

3. Connecting method (see figure 6, 7, 8):

## Model UT232: OPERATING MANUAL

- When measuring 3 phase 4 wires, connect the Meter as figure 6

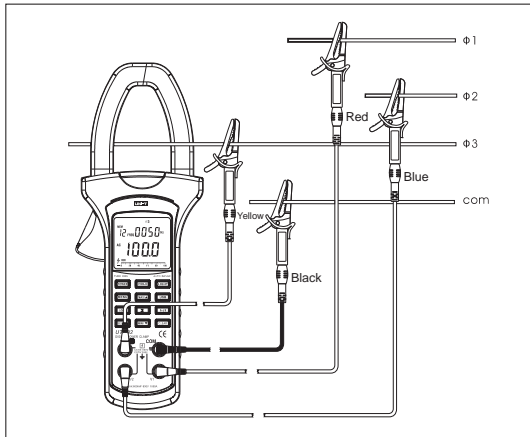

Figure 6

- Insert red test leads to **V1** input terminal.
- Insert blue test leads to **V2** input terminal
- Insert yellow test leads to **V3** input terminal and connecting it to every live wire of the 3 phase.
- Insert black test leads to **COM** input terminal and connect it to the neutral wire of the 3 phase.

- When measuring 3 phase 3 wires, connect the Meter as figure 7

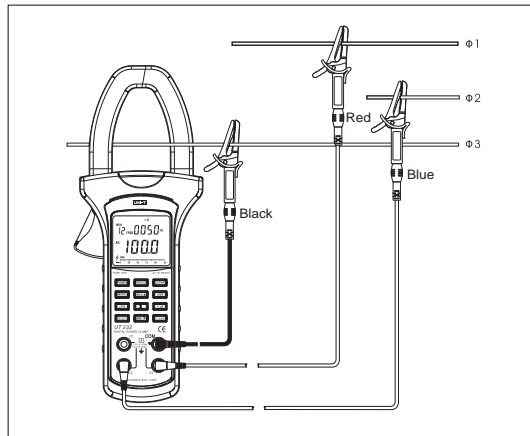

Figure 7

- Insert red test leads to **V1** input terminal.
- Insert blue test leads to **V2** input terminal
- Insert black test leads to **COM** input terminal and connect it to the neutral wire of the 3 phase.

## Model UT232: OPERATING MANUAL

- When measuring single phase 2 wires, connect the Meter as figure 8

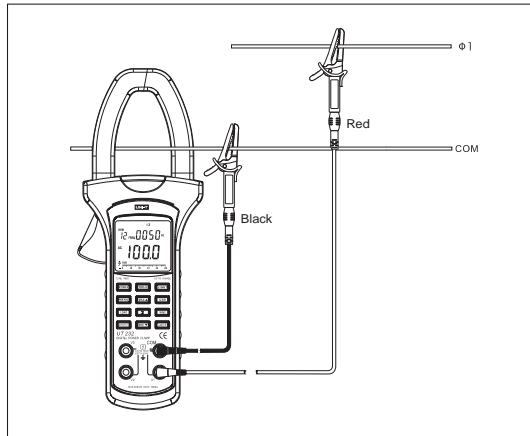

Figure 8

- Insert red test lead to **V1, V2** or **V3** input terminal corresponding to one of Ø1, Ø2 or Ø3 phase
- Insert black test leads to **COM** input terminal.
- Connecting the two test leads to live and neutral wires.

4. When measuring 3 phases 4 wires:  
(see figure 9, 10, 11, 12, 13, 14, 15, 16)

- Press **SELECT** to choose first phase Ø1, see figure 9. The double displays show the active power kW value and also the PG value of Ø1.

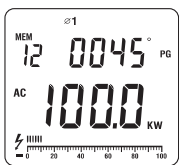

Figure 9

- If necessary, press  $\Sigma$  to get the sum of watts as figure 10.

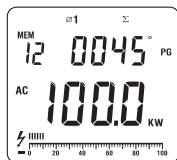

Figure 10

- After sum up the current power measurement value of the first phase, then press **SELECT** to choose the second phase Ø2, as figure 11

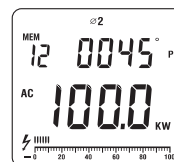

Figure 11

- The double display shows the value of active power kW and PG of Ø2.
- If necessary, press  $\Sigma$  to get the sum of watts as figure 12.

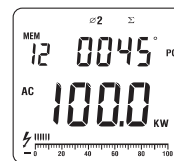

Figure 12



## Model UT232: OPERATING MANUAL

- After sum up the current power measurement value of the second phase, then press **SELECT** again to choose the third phase  $\varnothing 3$ , as figure 13.

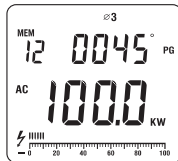

Figure 13

- The double display shows the value of active power KW and PG of  $\varnothing 3$ .
- If necessary, press  $\Sigma$  to get the sum of watts as figure 14.

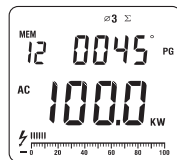

Figure 14

- After sum up the current power measurement value of the third phase, finally press **SELECT** again to display the 3 phase sum of active power value and reactive power value.
- Press **MAX/▲** or **MIN/▼** as figure 15 to step through in sequence three phase sum of active power+three phase sum of reactive power, and three phase sum of power factor + 3 phase sum of apparent power.

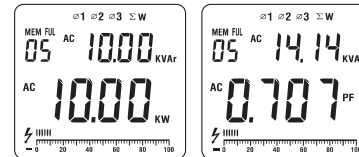

Figure 15

### 5. When measuring 3 phase 3 wires:

- The first and second phase measuring method is same as 3 phase 4 wires.
- Jump over the third phase measurement.
- Press **SELECT** to display the 3 phase sum of active power and reactive power.
- Press **MAX/▲** or **MIN/▼** as figure 16 to step through in sequence three phase sum of active power+three phase sum of reactive power, and three phase sum of power factor + 3 phase sum of apparent power.

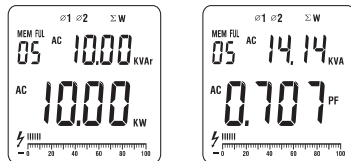

Figure 16

6. The maximum power is 600kW of single phase, **OL** will be displayed when it is over than that. The maximum range is 1800kW of three phase sum of

active power, **OL** will be displayed when it is over than that.

7. Press **MAX/▲**, the display shows MAX, it starts recording the maximum active power value. Press again to display the current active power value.
8. Press **MIN/▼**, the display shows MIN, it starts recording the minimum active power value. Press again to display the current active power value.

### Note

- When there is no input or single phase, the Meter displays OL.  $\Sigma$  button is not valid.
- It can only sum up the current measurement value. The maximum and minimum value cannot be summed up.
- Only at this range can carry out sum of watts measurement, other ranges cannot carry out this measurement.
- When testing has been completed, disconnect the connection between the testing leads and the circuit under test and remove testing leads from the input terminals.

### D. Apparent Power (main display) + Reactive Power (secondary display) Measurement

#### Warning

To avoid damages to the Meter or harms to you, do you measure higher than AC voltage 600V rms and AC current 1000A rms.

To test for Apparent power (main display) + Reactive power (secondary display), connect the Meter as follows:

1. Press the **MENU** to select Apparent power (main display) + Reactive power (secondary display) range.
2. Press the lever to open the transformer jaw, and clamp them to the corresponding phase of tested conductor. If user needs to measure any phase of the 3 phase, then clamp them to that phase's conductor.
3. The connecting method of 3 phases 4 wires, 3 phases 3 wires or single phase 2 wires, see figure 6, 7 and 8

4. When measuring 3 phase 4 wires: (see figure 17, 18, 19)

- Press **SELECT** to choose the first phase Ø1, see figure 17.

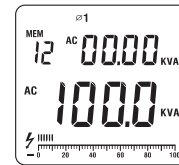

Figure 17

- The double display shows the first phase value of apparent power kVA and reactive power Kvar.
- Then press **SELECT** again to choose the second phase Ø2, see figure 18.

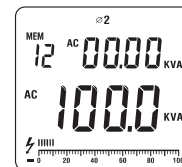

Figure 18

- The double display shows the second phase value of apparent power kVA and reactive power Kvar.
- Press **SELECT** again to choose the third phase  $\varnothing 3$ , see figure 19.

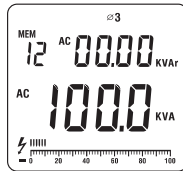

Figure 19

- The double display shows the third phase value of apparent power kVA and reactive power Kvar.
5. When measuring 3 phase 3 wires:
    - The first phase and second phase operating method is same as three phase 4 wires.
    - Jump over the third phase measurement.
  6. The maximum measuring range is 600kW when measuring single phase apparent power kVA and reactive power Kvar, **OL** will be displayed when it is over than that.
  7. Press **MAX/▲**, the display shows MAX, it starts recording the maximum apparent power value. Press again to display the current apparent power value.
  8. Press **MIN/▼**, the display shows MIN, it starts recording the minimum apparent power value. Press again to display the current apparent power value.

### Note

- When testing has been completed, disconnect the connection between the testing leads and the circuit under test and remove testing leads from the input terminals.

### E. Power Factor (main display) + Phase Angle (secondary display) Measurement

#### Warning

To avoid damages to the Meter or harms to you, do you measure higher than AC voltage 600V rms and AC current 1000A rms.

To test for Power factor (main display) + Phase angle (secondary display), connect the Meter as follows:

1. Press the **MENU** to select Power factor (main display) + Phase angle (secondary display) range.
2. Press the lever to open the transformer jaw, and clamp them to the corresponding phase of tested conductor. If user needs to measure any phase of the 3 phase, then clamp them to that phase's conductor.
3. The connecting method of 3 phases 4 wires, 3 phases 3 wires or single phase 2 wires, see figure 6, 7 and 8
4. When measuring 3 phase 4 wires: (see figure 20, 21, 22)

- Press **SELECT** to choose the first phase Ø1, see figure 20.

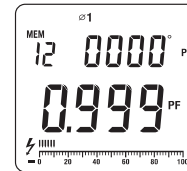

Figure 20

- The double display shows the first phase value of power factor PF and phase angle PG.
- Then press **SELECT** again to choose the second phase Ø2, see figure 21.

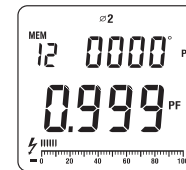

Figure 21

- The double display shows the second phase value of power factor PF and phase angle PG.
- Press **SELECT** again to choose the third phase  $\varnothing 3$ , see figure 22.

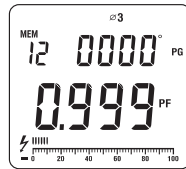

Figure 22

- The double display shows the third phase value of power factor PF and phase angle PG.

5. When measuring 3 phase 3 wires:
  - The first phase and second phase operating method is same as three phase 4 wires.
  - Jump over the third phase measurement.
6. MAX/▲ and MIN/▼ are not valid when measuring power factor.

### Note

- When testing has been completed, disconnect the connection between the testing leads and the circuit under test and remove testing leads from the input terminals.

### F. Active Energy (main display) + Time (secondary display) Measurement



#### Warning

To avoid damages to the Meter or harms to you, do you measure higher than AC voltage 600V rms and AC current 1000A rms.

To test for Active Energy (main display) + Time (secondary display), connect the Meter as follows:

1. Press the **MENU** to select Power factor (main display) + Phase angle (secondary display) range.
2. Press the lever to open the transformer jaw, and clamp them to the corresponding phase of tested conductor. If user needs to measure any phase of the 3 phase, then clamp them to that phase's conductor.
3. The connecting method of 3 phase 4 wires, 3 phases 3 wires or single phase 2 wires, see figure 6, 7 and 8
4. Press **SELECT** to choose one of the three phases ( $\varnothing 1$ ,  $\varnothing 2$ ,  $\varnothing 3$ ), see figure 23.

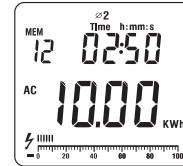

Figure 23

- The double display shows the value of tested object's active energy kWh value and the measuring time of the corresponding phase.
- The measuring reading gets increasing along with the time increases. Press **HOLD** to read a particular time kWh value. Then the reading and time are locked, but still continuous accumulate measuring time.
- After read the data, press **HOLD** again to continuous measurement. kWh value continuous accumulate and the measuring time jumps to the present measuring time.
- When the measuring time is over 24 hours or the Meter is switched to other measuring ranges, active energy measuring will stop.

- The maximum reading of active energy is 9999kWh. **OL** will be displayed when the reading is over than that.
5. **MAX/▲** and **MIN/▼** are not valid when measuring active energy.
  6. Press **CLEAR** to reset the time.

### Note

- When there is no input signal, it cannot carry out active energy measurement.
- When there is input signal, the maximum waiting time is around 10s before timing.
- When testing has been completed, disconnect the connection between the testing leads and the circuit under test and remove testing leads from the input terminals.







### True RMS Measurement and Average Value Measurement

The True RMS measurement method can measure accurately the effective value of non-sine wave input signal.

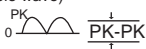
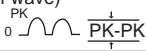

Average value measurement method can measure the mean value of one sine wave input signal, and then displays it as RMS value

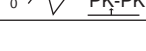
When the input waveform has distortion, measuring tolerance will be included. The total tolerance depends on the total distortion. Below table 1 shows the waveform coefficient and the relationship and the requested changing factor of sine wave, square wave, pulse rectangle wave, sawtooth triangle wave, RMS value and average value.

Input Wave	PK-PK	0-PK	RMS	AVG
Sine 	2.828	1.414	1.000	0.900
sine commute (whole wave) 	1.414	1.414	1.000	0.900
sine commute (half wave) 	2.828	2.828	1.414	0.900
square wave 	1.800	0.900	0.900	0.900
commuted square wave 	1.800	1.800	1.272	0.900
pulse rectangle D=X/Y 	0.9/D	0.9/ D	0.9D/2	0.9/D
sawtooth triangle 	3.600	1.800	1.038	0.900

### Specifications

#### A. General Specifications

- Maximum Voltage between any Terminals and grounding: Refer to different range input protection voltage.
- Display: Multi LCD displays, Maximum display 9999.
- Ranges: Auto
- Overloading: Display **OL**.
- Battery Deficiency: Display .
- Data Holding: Display .
- Data Logging: Maximum 99, Single or Continuous records
- Data Recall
- Maximum and Minimum value display: Voltage, Current, Active Power and Apparent Power ranges
- Display Backlight: White colour
- Computer connection: USB
- Calibration Feature
- Sleep Mode: To preserve battery life, the Meter automatically turns off if you do not turn press any button for around 15 minutes., except at active factor range.
- Sampling: 3 times per second.
- Max. Jaw Size: 55mm diameter.
- Analogue Bar Graph
- Power: 4 x 1.5V battery (LR6)
- Dimensions: 303mm x 112mm x 39mm
- Weight: Approximate 601g

### B. Environmental Requirements

- The Meter is suitable for indoor use.
- Altitude: Operating: 2000m  
Storage: 10000m
- Temperature and humidity:
  - Operating:
    - 0°C ~ 30°C (≤85%R.H)
    - 30°C ~ 40°C (≤75%R.H)
    - 40°C ~ 50°C (≤45%R.H)
  - Storage:
    - 10°C ~ +60°C (≤85%R.H)
- Safety/ Compliances: IEC 61010 CAT.III 600V, CAT.IV 300V overvoltage and double insulation standard, pollution degree 2.
- Certification: **CE**

### Accurate Specifications

Accuracy:  $\pm(a\% \text{ reading} + b \text{ digits})$ , guarantee for 1 year.

Operating temperature:  $23^{\circ}\text{C} \pm 5^{\circ}\text{C}$

Operating humidity: 45~75%R.H

#### A. AC Voltage (True RMS)

Range	Resolution	Accuracy	Allowable Maximum overload protection voltage	Input Impedance
15V	0.1V	$\pm(1.2\%+5)$	600 RMS	10M $\Omega$
100V				
300V				
600V				

#### B. Frequency

Range	Resolution	Accuracy
20Hz~500Hz	1Hz	$\pm(0.5\%+5)$

### C. AC Current (True RMS)

Range	Resolution	Accuracy	Allowable Maximum overload protection current
40A	0.1A	±(2%+5)	1000A RMS
100A			
400A			
1000A	1A		

### D. Active Power ( $W = V \times A \times \cos \phi$ )

Current / Voltage		Voltages Range			
		15V	100V	300V	600V
Current Range	40A	0.60kW	4.00kW	12.00kW	24.00kW
	100A	1.50kW	10.00kW	30.00kW	60.00kW
	400A	6.00kW	40.00kW	120.0kW	240.0kW
	1000A	15.00kW	100.0kW	300.0kW	600.0kW
Accuracy		±(3%+5)			
Resolution		<1000kW: 0.01kW ≥100kW: 0.1kW			

#### Remarks:

- Allowable maximum overload protection voltage: 600V RMS
- Allowable maximum overload protection current: 1000A RMS

### E. Apparent Power (VA = V x A)

Current / Voltage		Voltages Range			
		15V	100V	300V	600V
Current Range	40A	0.60kVA	4.00kVA	12.00kVA	24.00kVA
	100A	1.50kVA	10.00kVA	30.00kVA	60.00kVA
	400A	6.00kVA	40.00kVA	120.0kVA	240.0kVA
	1000A	15.00kVA	100.0kVA	300.0kVA	600.0kVA
Accuracy		± (3%+5)			
Resolution		<1000kVA: 0.01kVA ≥ 100kVA: 0.1kVA			

#### Remarks:

- Allowable maximum overload protection voltage: 600V RMS
- Allowable maximum overload protection current: 1000A RMS

**F. Reactive Power (Var = V x A x SIN Ø )**

Current / Voltage		Voltages Range			
		15V	100V	300V	600V
Current Range	40A	0.60kVar	4.00kVar	12.00kVar	24.00kVar
	100A	1.50kVar	10.00kVar	30.00kVar	60.00kVar
	400A	6.00kVar	40.00kVar	120.0kVar	240.0kVar
	1000A	15.00kVar	100.0kVar	300.0kVar	600.0kVar
Accuracy		15V/1000A Range: ± (4%+10)    Other Ranges: ± (4%+5)			
Resolution		<1000kVar: 0.01kVar ≥100kVar: 0.1kVar			

Remarks:

- Allowable maximum overload protection voltage: 600V RMS
- Allowable maximum overload protection current: 1000A RMS

### G. Power Factor (PF = W / VA)

Range	Accuracy	Resolution	Measuring Condition
0.3~1 (capacitive or inductive)	$\pm 0.022$	0.001	The minimum measuring current 10A The minimum measuring voltage 45V
0.3~1 (capacitive or inductive)	For reference only		Measuring current less than 10A OR Measuring voltage less than 45V

Remarks:

- Allowable maximum overload protection voltage: 600V RMS
- Allowable maximum overload protection current: 1000A RMS

### H. Phase Angle (PG=acos (PF))

Range	Accuracy	Resolution	Measuring Condition
0° ~360°	$\pm 1^\circ$	1°	The minimum measuring current 10A The minimum measuring voltage 45V
0° ~360°	For reference only		Measuring current less than 10A OR Measuring voltage less than 45V



### I. Active Energy (kWh)

Range	Accuracy	Resolution
1~9999kWh	$\pm(3\%+2)$	0.001kWh

#### Remarks:

- Allowable maximum overload protection voltage: 600V RMS
- Allowable maximum overload protection current: 1000A RMS

### MAINTENANCE

This section provides basic maintenance information including battery replacement instruction.

#### Warning

**Do not attempt to repair or service your Meter unless you are qualified to do so and have the relevant calibration, performance test, and service information.**

**To avoid electrical shock or damage to the Meter, do not get water inside the case.**

#### A. General Service

- Periodically wipe the case with a damp cloth and mild detergent. Do not use abrasives or solvents.
- To clean the terminals with cotton bar with detergent, as dirt or moisture in the terminals can affect readings.
- Turn the Meter power off when it is not in use.
- Take out the battery when it is not using for a long time.
- Do not use or store the Meter in a place of humidity,

high temperature, explosive, inflammable and strong magnetic field.

### B. Replacing the Battery (see figure 24)

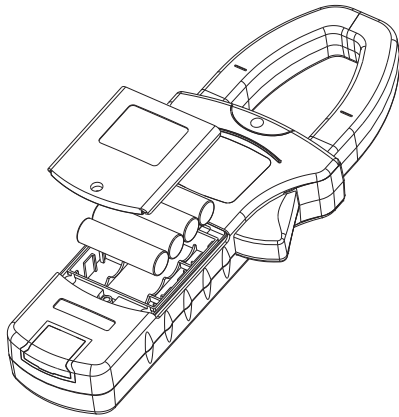



Figure 24

### Warning

To avoid false readings, which could lead to possible electric shock or personal injury, replace the battery as soon as the battery indicator “ ” appears.

**Make sure the transformer jaw and the tests leads are disconnected from the circuit being tested before opening the case bottom.**

To replace the battery:.

1. Press **POWER** to turn the Meter off and remove all the connections from the input terminals
2. Turn the Meter's front case down.
3. Remove the screw from the battery door, and separate the battery door from the case bottom.
4. Take out the old battery and replace with 4 x 1.5V battery (LR6).
5. Rejoin the case bottom and the battery compartment, and reinstall the screw.

**\*END\***

This operating manual is subject to change without notice.

©Copyright 2007 Uni-Trend Group Limited.  
All rights reserved.

Manufacturer:  
Uni-Trend Technology (Dongguan) Limited  
Dong Fang Da Dao  
Bei Shan Dong Fang Industrial Development District  
Hu Men Town, Dongguan City  
Guang Dong Province  
China  
Postal Code: 523 925

Headquarters:  
Uni-Trend Group Limited  
Rm901, 9/F, Nanyang Plaza  
57 Hung To Road  
Kwun Tong  
Kowloon, Hong Kong  
Tel: (852) 2950 9168  
Fax: (852) 2950 9303  
Email: [info@uni-trend.com](mailto:info@uni-trend.com)  
<http://www.uni-trend.com>